

Felt Needle Book

A Sewing.com Practice Project

Practice 4 basic hand stitches by making something you'll actually use.

Skill: Complete Beginner | **Time:** 45–60 minutes | **Machine required:** None

What You'll Learn



Running Stitch

Used for quick, temporary basting holds.



Backstitch

The strongest hand-sewn seam for structural strength.

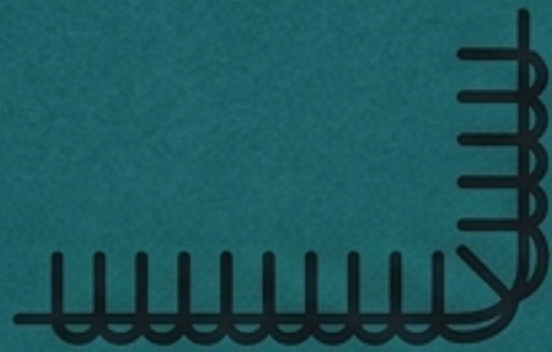

Blanket Stitch

Secures raw edges with a decorative, looped border.



Slip Stitch

Creates an invisible seam for attaching pockets or hems.

Materials & Tools Checklist

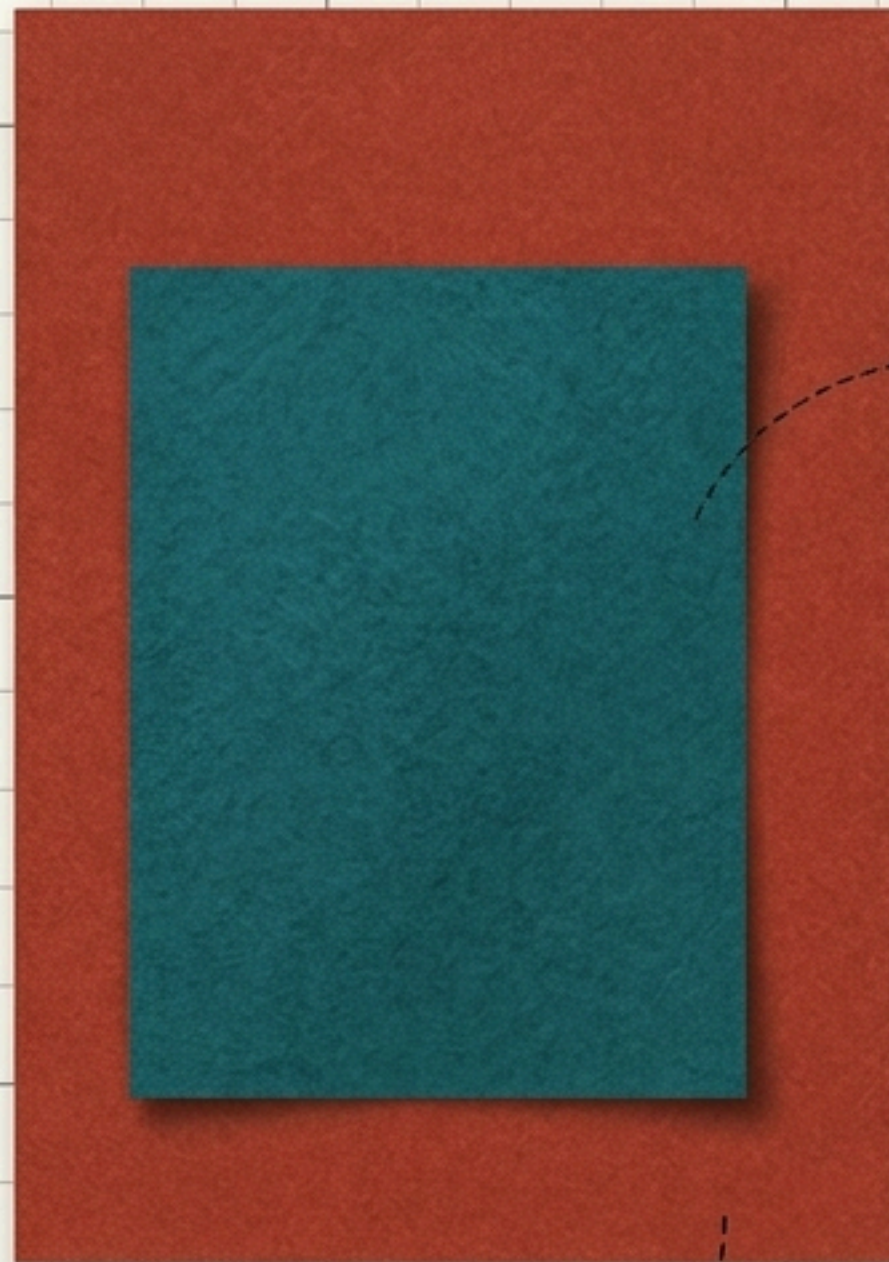

Outer Cover:
1 sheet (9x12 inches)
Wool-blend felt.

Inner Pages:
1 piece (6x8 inches)
contrasting felt.

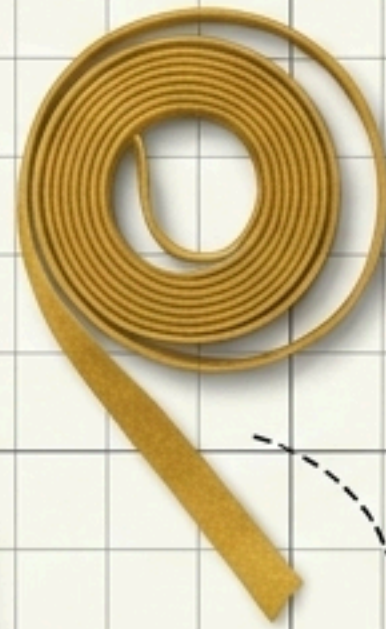

Closure:
1 piece (12 inches)
narrow ribbon.

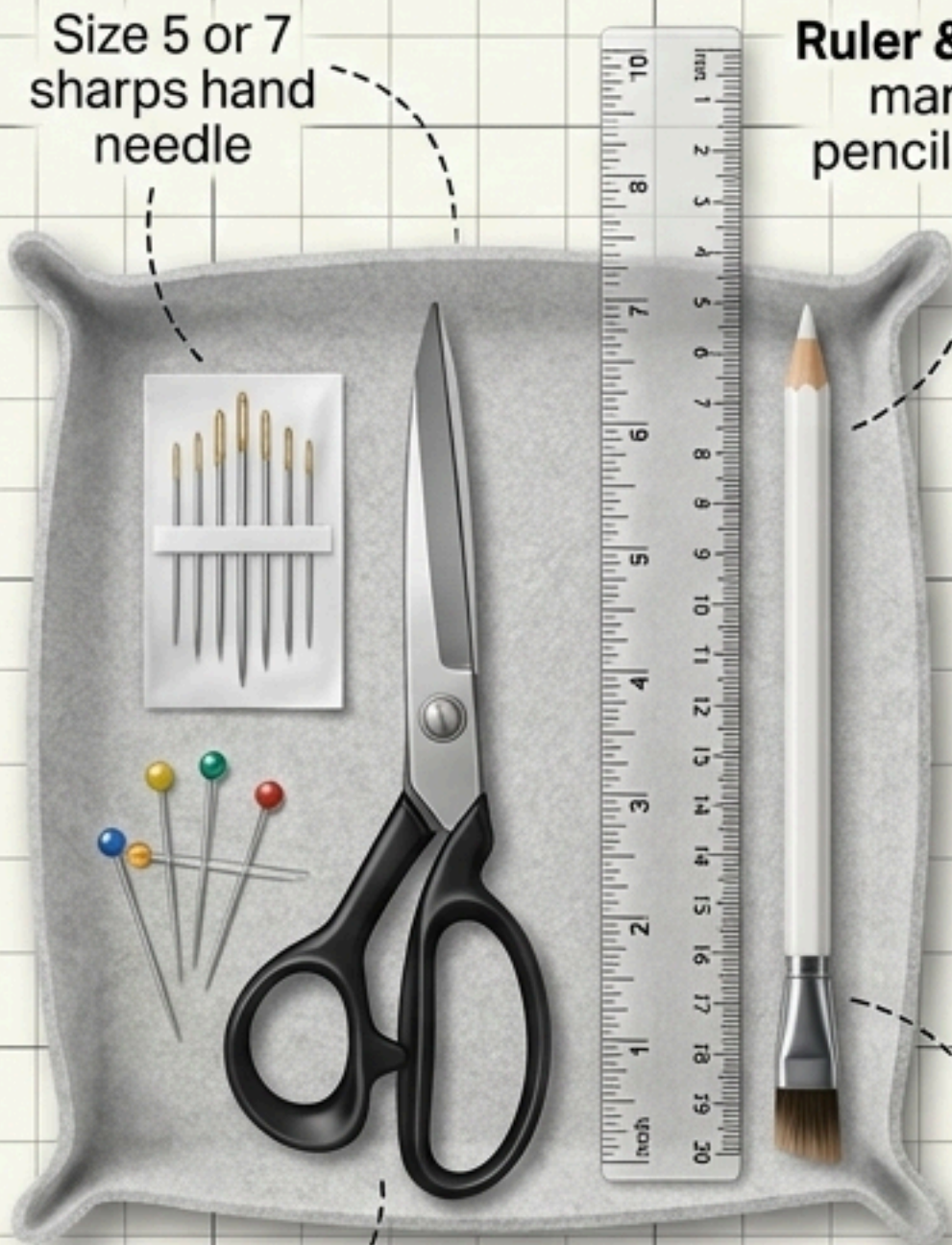

Size 5 or 7
sharps hand
needle

**Fabric
scissors**

**Ruler & Fabric
marking
pencil (chalk)**

**Ruler &
Fabric marking
pencil (chalk)**



Embroidery floss
(contrasting color)



**All-purpose
polyester thread**
(matching outer felt)

*Cost Estimate:
Under \$10 total
(or under \$3 if using
stash scraps!).*

Why Felt?

It doesn't fray! No seam allowances, no complex hems, just cut and sew.



The Best Choice: Wool-Blend Felt

Offers the best body and durability. Holds needles securely without tearing.

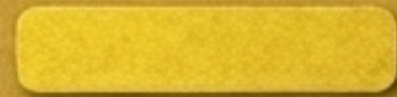

The Acceptable Alternative: Acrylic Craft Felt

At \$0.30/sheet, it's great for practice, but will pill and lose its shape faster over time.



What to Avoid: Fleece, Cotton, Adhesive

Fleece stretches; cotton frays (requires complex seams); adhesive gums up your needle.

Step 1: Pattern Layout & Cutting

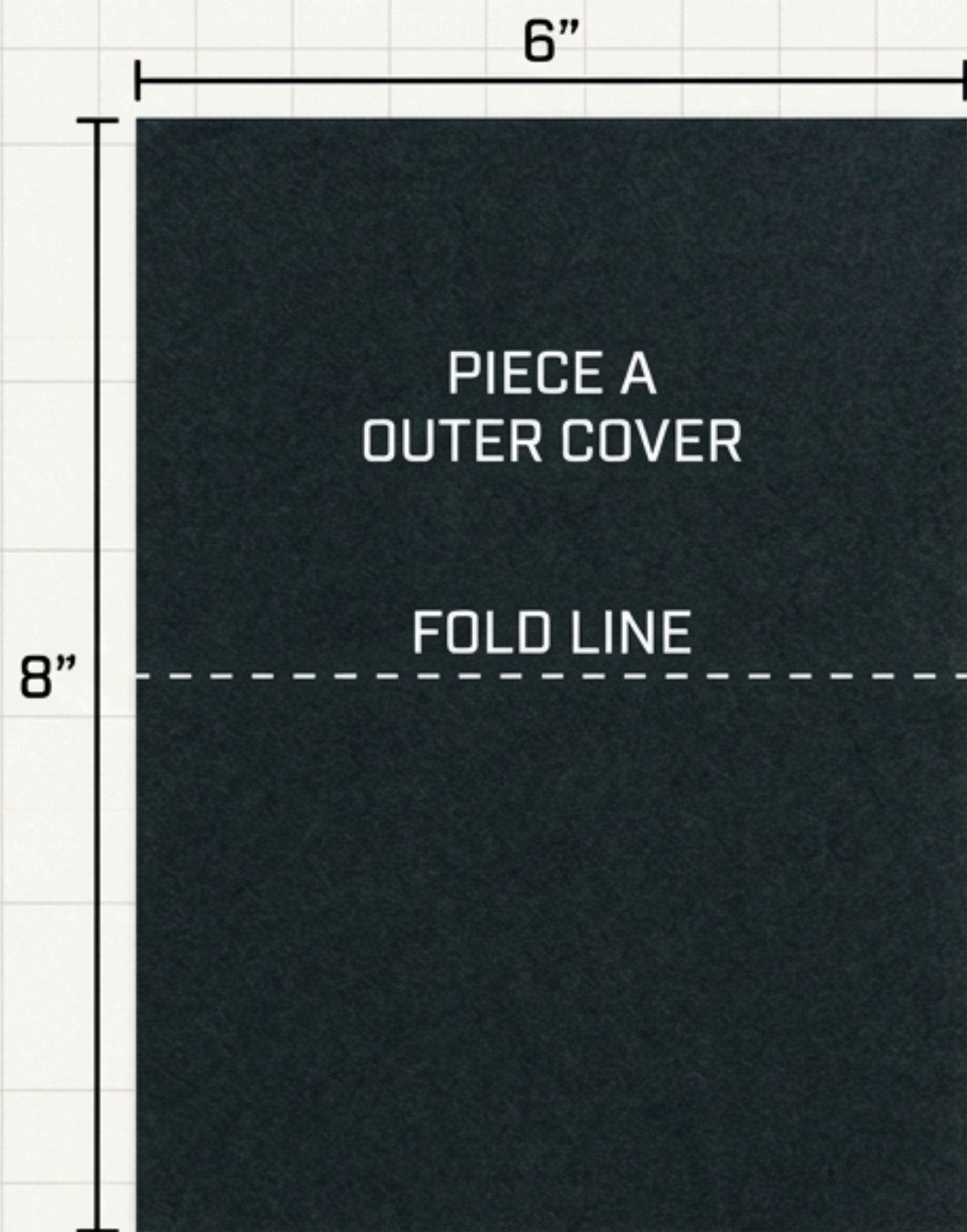

Piece A (Outer Cover)
Cut 1 (Dark Felt)

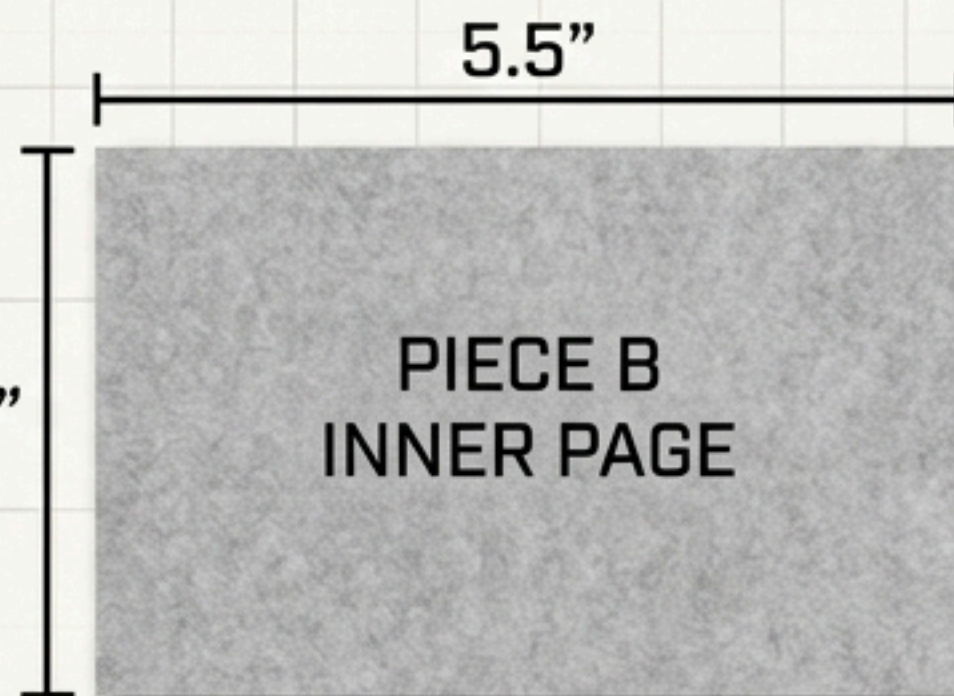

Piece B (Inner Pages)
Cut 2 (Light Felt)

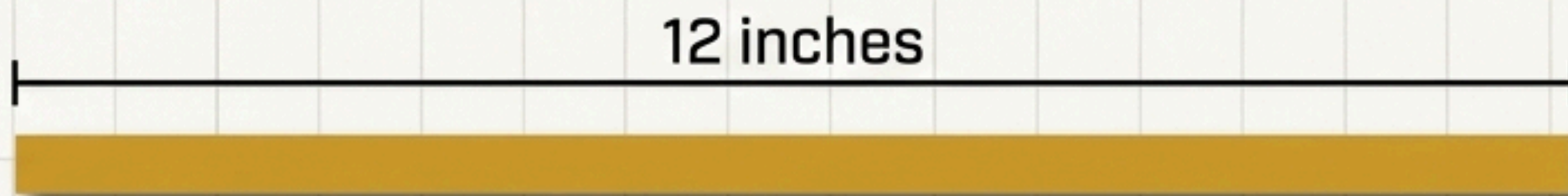

Piece C (Closure): 12 inches long
Cut 1 (Narrow Ribbon)

Tip: Cut on a flat, hard surface. Cutting on a soft carpet makes felt shift, causing jagged edges.

Step 2: Create the Spine

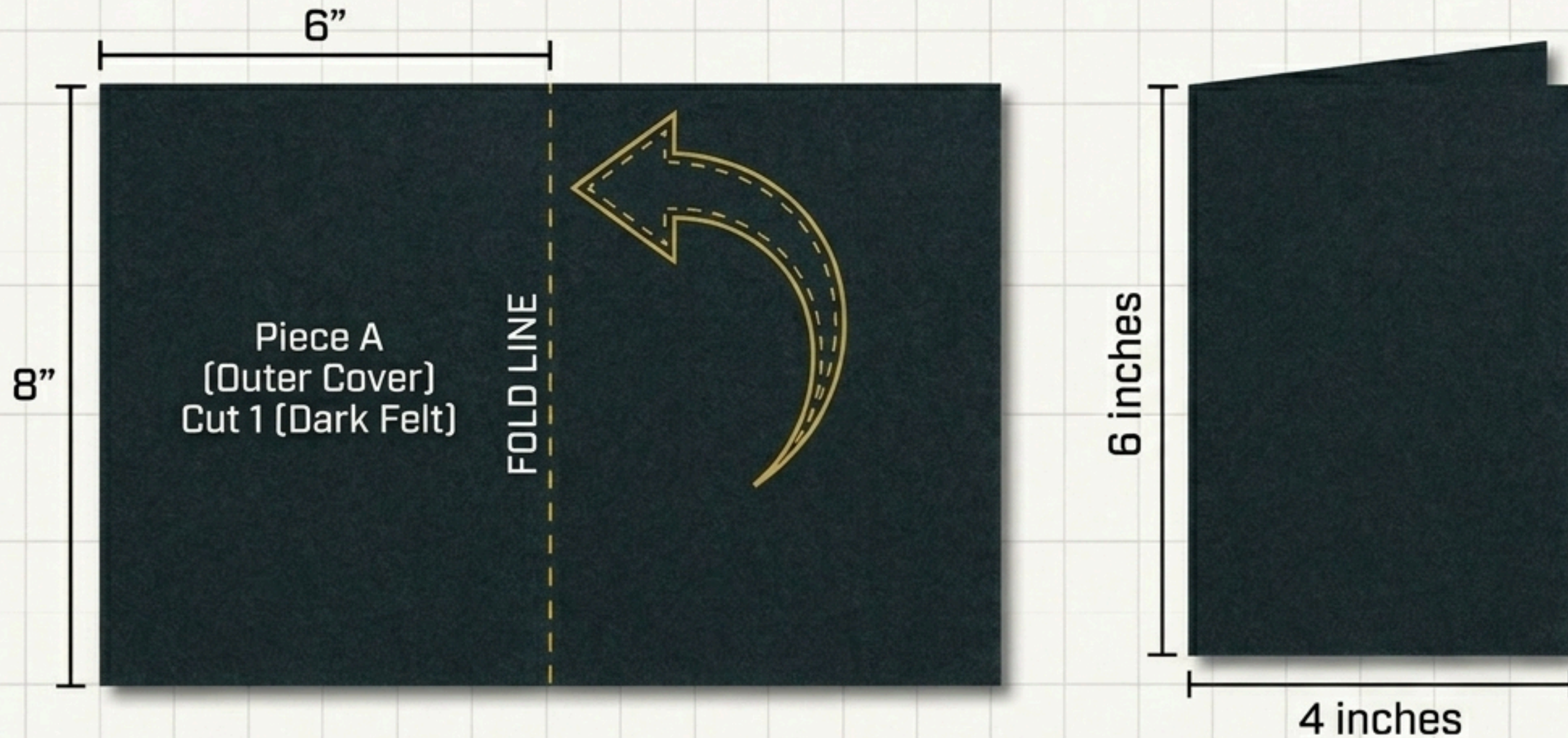

Bring the two 6-inch edges together to create the book's spine. The finished book is now 6 inches wide and 4 inches tall.

Tip: Felt can be stubborn! Press the fold firmly with your fingers, or use a warm iron on low heat (no steam) for a crisp crease.

Steps 3 & 4: Position and Baste the Ribbon

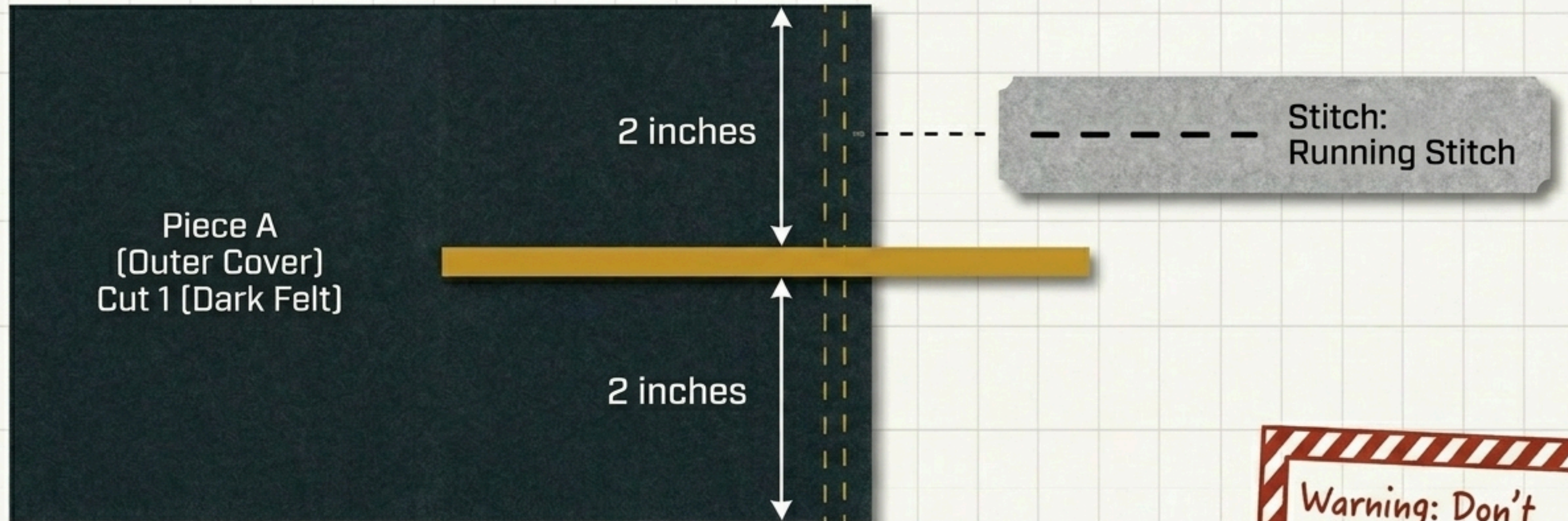

Open the cover. Place the ribbon so half sits inside, half extends past the right edge. Sew a temporary Running Stitch through the ribbon and felt, 1/4 inch from the right edge.

Warning: Don't stitch too far inward! Keep within 1/4 inch of the edge, or the ribbon will bunch up when folded.

Step 5: Secure the Ribbon



Stitch:
Backstitch

Sew 4-5 tight Backstitches directly over your basted line using matching polyester thread. Pull each stitch snug.

*Why backstitch?
It's the strongest
hand-sewn seam.
This ribbon needs to
survive repeated
tugging and tying!*

Step 6: Position the Inner Pages

Center the two 5.5 by 3.5 inch pages on the left and right halves of the open cover. Ensure they do NOT overlap the center fold line.

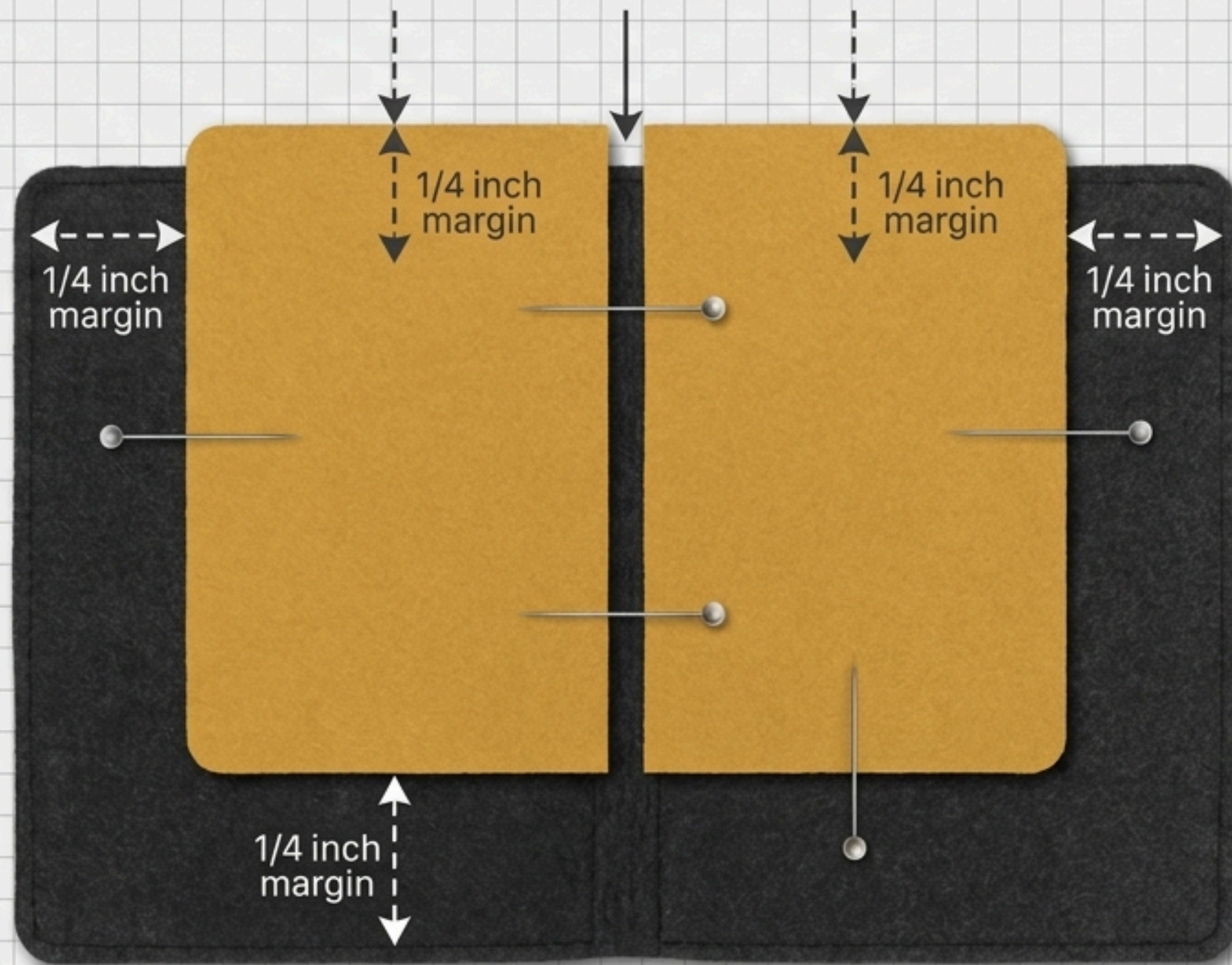

Pins are your best friend here. Pinning through felt holds securely without slipping.

Step 7: Stitch the Spine



Stitch:
Backstitch

Fold the book closed. Sew tight, 1/8 inch backstitches straight down the fold line using matching polyester thread.

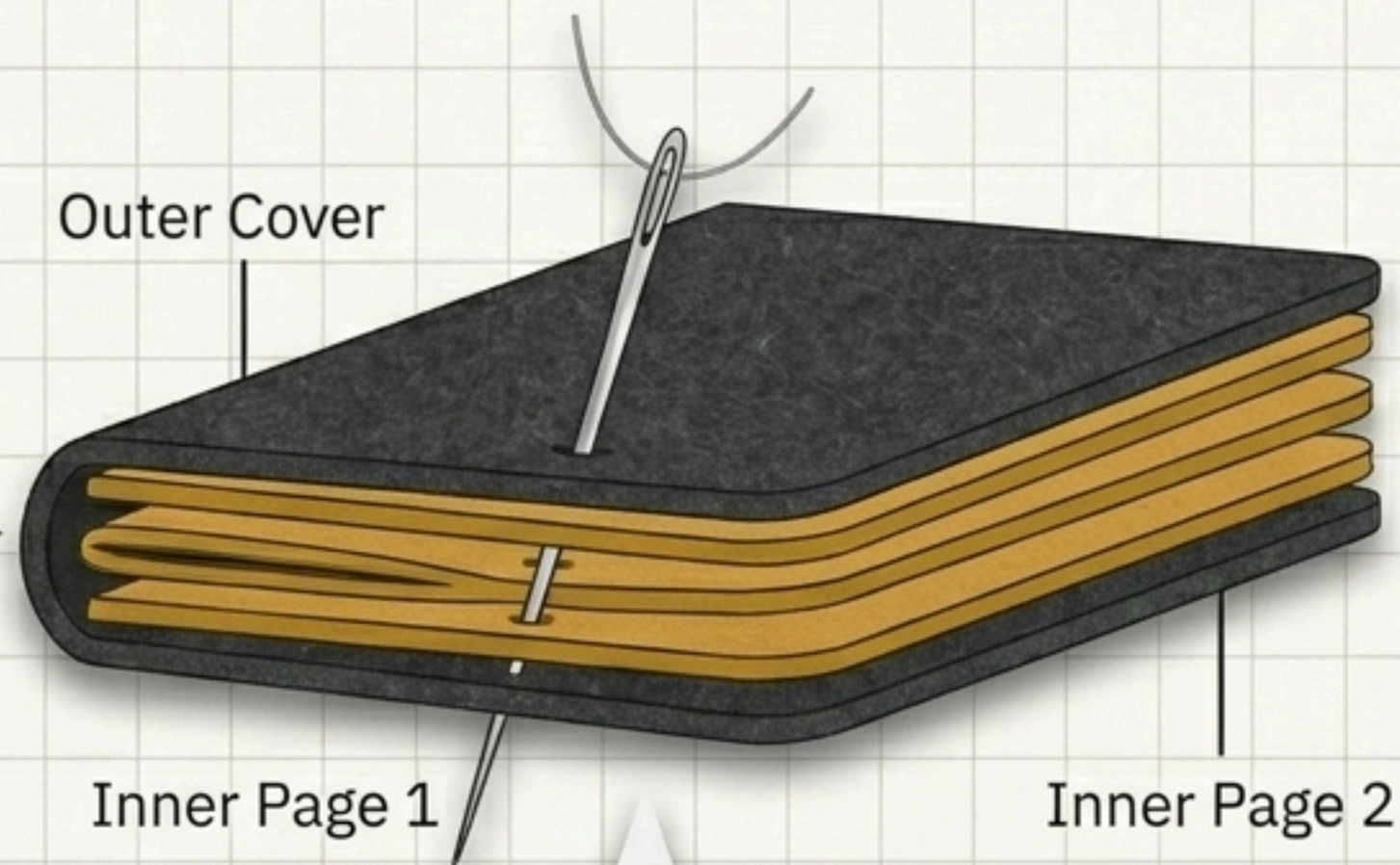

***Common Mistake:** Missing a layer. Before pulling each stitch tight, flip the book to confirm your needle pierced the cover AND both inner pages.*

Step 8: Blanket Stitch the Edges

Switch to contrasting embroidery floss.

Start at the bottom-left corner and work your way completely around the perimeter. This secures the raw edges with a decorative border.

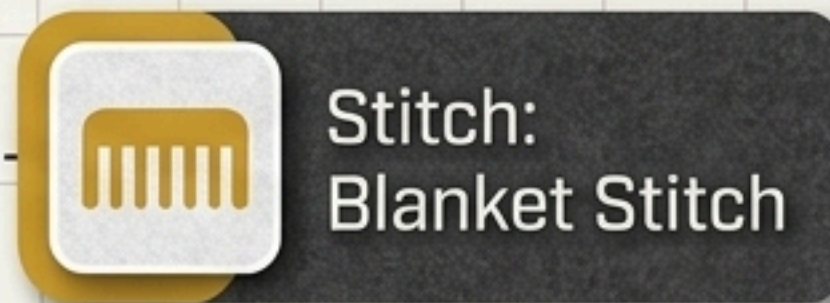
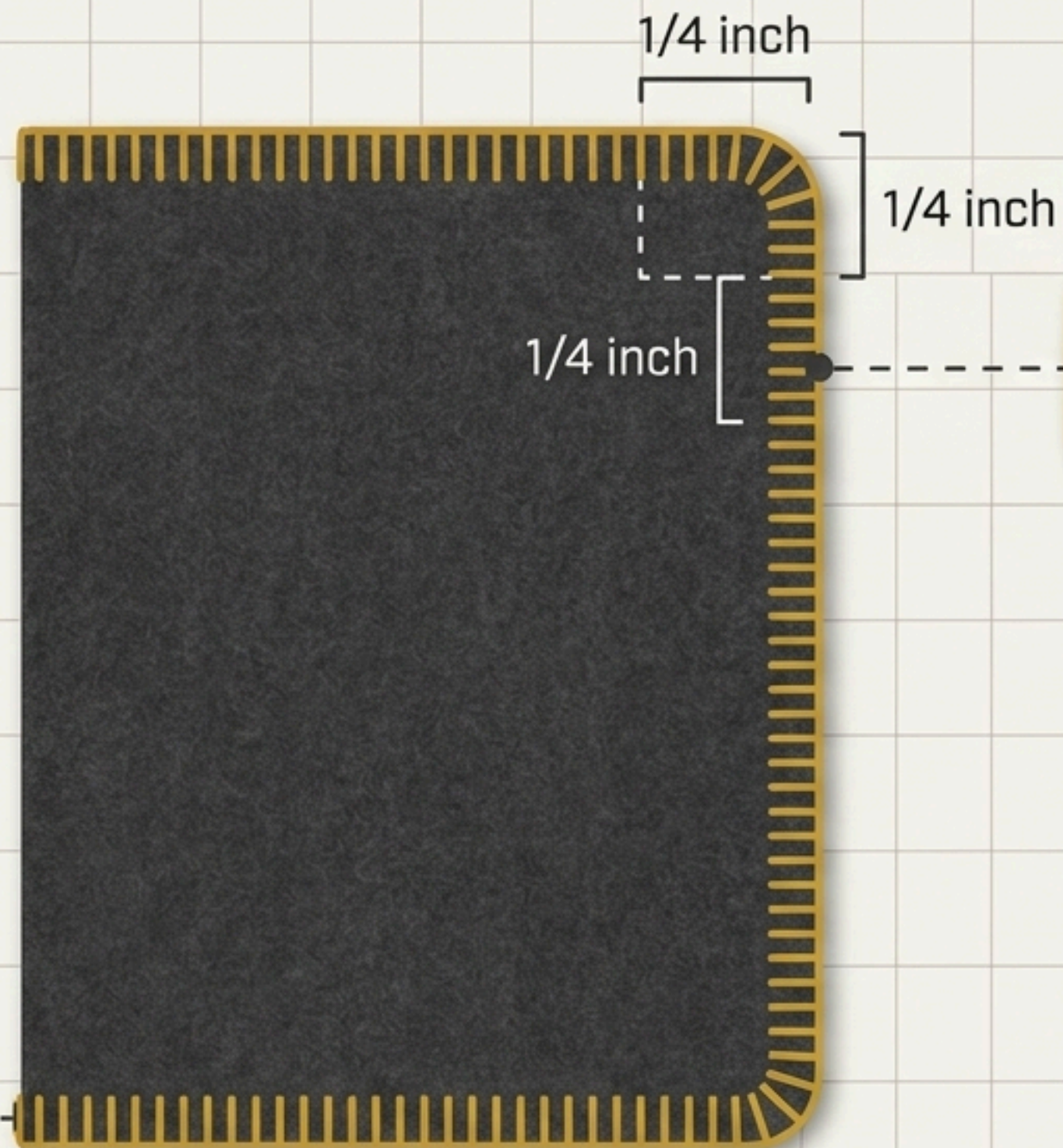

Struggling with uneven loops? Lightly mark your 1/4-inch intervals with a fabric pencil first. Chalk brushes right off felt!

Step 9: Securing the Threads Invisibly

When you complete the perimeter, overlap your final stitch with your first. **Do NOT tie** a bulky knot on the **surface**. Instead, make 2-3 tiny backstitches hidden underneath the blanket stitch loop to lock it.

Trim the excess thread flush with the fabric. The hidden backstitches provide all the friction needed to hold the thread forever.

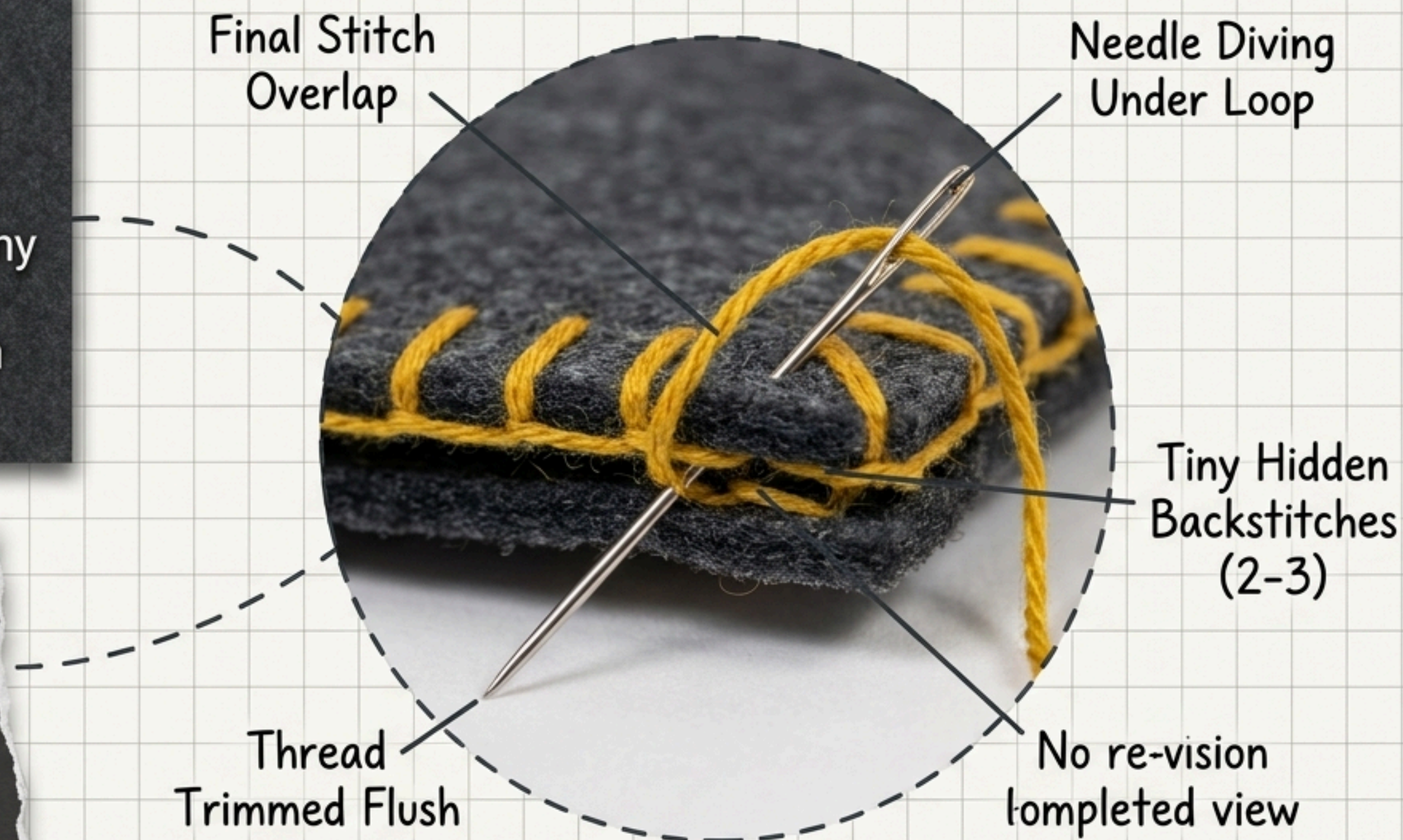

Step 10: Final Inspection & Bonus Challenge

Final Inspection

Fold inverted felt
caultriet

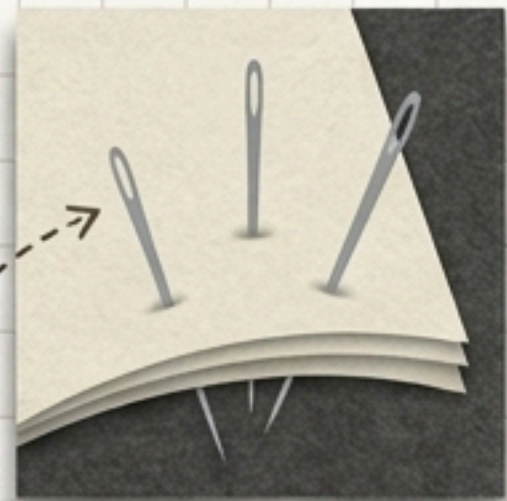

Fold closed, wrap, and tie the ribbon.
Push 3-4 needles into the inner pages.
*(If needles push all the way through, your
felt is too thin—add a 3rd page next time!)*

The Bonus Challenge



Stitch:
Slip Stitch

Bonus Challenge: Want to learn the Slip Stitch?
Cut a 2x3 inch felt scrap. Use a hidden slip stitch
on three sides to attach it to an inner page.
Perfect for holding a needle threader!

Your Completed Needle Book

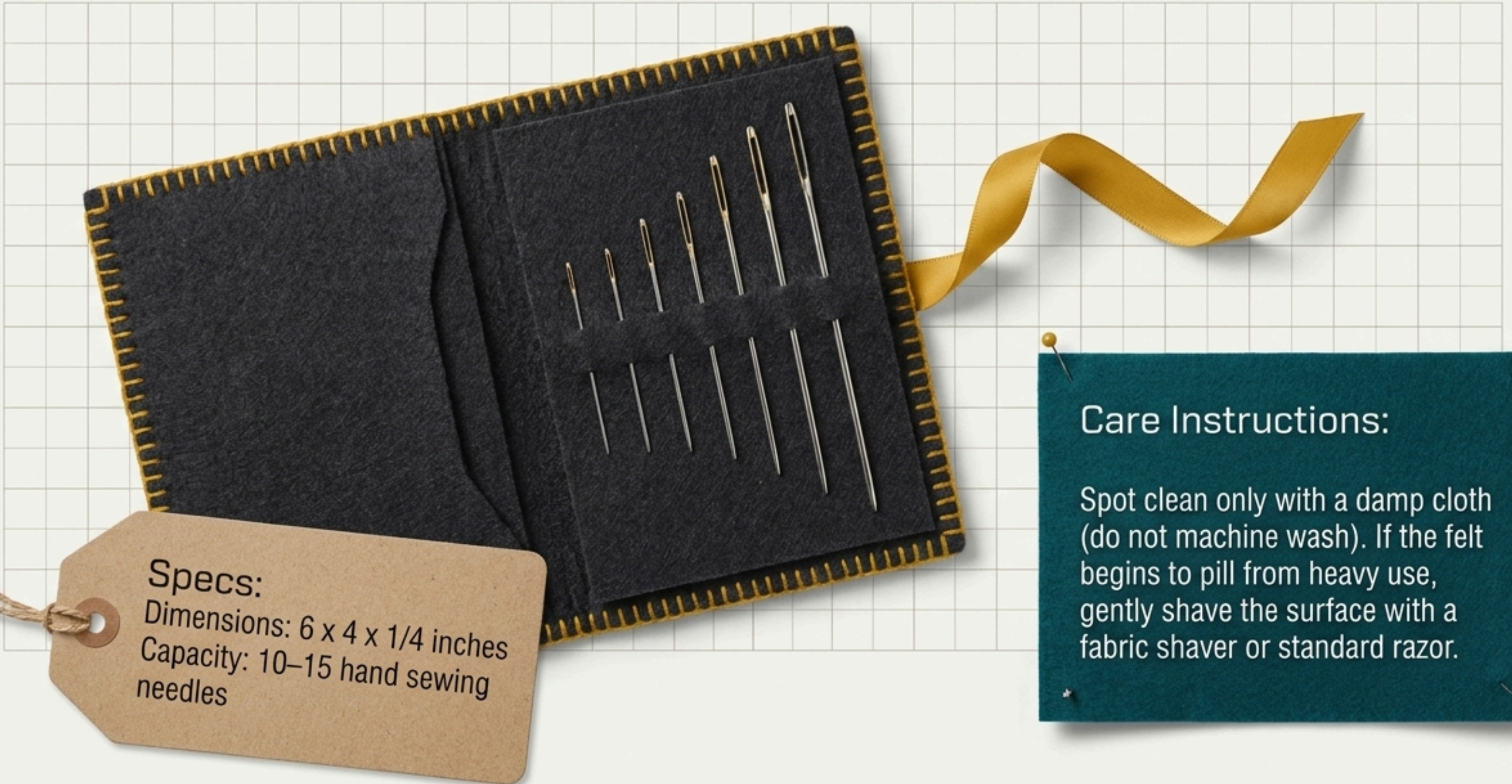

Specs:
Dimensions: 6 x 4 x 1/4 inches
Capacity: 10–15 hand sewing
needles

Care Instructions:

Spot clean only with a damp cloth (do not machine wash). If the felt begins to pill from heavy use, gently shave the surface with a fabric shaver or standard razor.

The Mechanics of Sewing: What You Just Learned

Action:
Basting Ribbon

Used: Running Stitch

Theory: Quick, temporary hold.

Action:
Securing Spine

Used: Backstitch

Theory: Maximum structural strength.

Action:
Edge Finishing

Used: Blanket Stitch

Theory: Structural border + Ornamentation.

Action:
Bonus Pocket

Used: Slip Stitch

Theory: Invisible seams & attachments.

You've mastered 4 of the 7 basic stitches. Ready for the rest? Access the complete Basic Sewing Stitches Reference Guide and download the practice PDF at [Sewing.com](https://www.sewing.com).